



L10 Dual Monaural Line Preamp

User Manual



Dear Valued Customer,

We are honored that you chose the L10 Dual Monaural Line Preamplifier. Our team has made every effort in the design and manufacture of this top quality versatile and future-proof product and is proud to present it to you. We hope your L10 preamplifier will bring you uncountable hours of emotional connection with your music collection.

But before you embark on your musical journey, we kindly request your attention to the information contained in this manual. The L10, as you will discover in the following pages, is a Swiss precision product designed for ultimate performance and flexibility. However, delivering that ground breaking sonic and musical excellence requires your unit to be setup and operated correctly. That is what this manual is all about. If you have any questions or require assistance, please don't hesitate to contact your authorized dealer.

Once properly installed and configured, we are confident that you will enjoy your L10 preamplifier for many years.

The Concert has just begun...

Cossy F.

A red handwritten signature consisting of a stylized 'C' followed by a horizontal line and a vertical line.

Heeb T.

A red handwritten signature consisting of a stylized 'H' followed by a horizontal line and a vertical line.



Table of contents

1	Introduction	
1.1	Global audio options	4
1.2	Input-specific options	4
1.3	More user configurable options	4
1.4	The purpose of this manual	4
2	Setting up your L10	
2.1	Safety notice	5
2.2	Unpacking	5
2.3	Package contents	6
2.4	Placing your L10, connecting the two chassis together and installing the spikes	6
2.5	Stacking the L10 (or not)	8
2.6	Connections	9
2.6.1	USB port	10
2.6.2	Ethernet port	10
2.6.3	Local area network considerations	11
2.6.4	Ground lift	11
2.6.5	Inputs	11
2.6.6	Outputs	11
2.6.7	AC Power	11
3	How to configure and operate your L10	12
3.1	Control actions in normal mode	13
3.1.1	To turn the L10 on	13
3.1.2	To select an input	13
3.1.3	To alter volume	13
3.1.4	To engage shortcuts (mute, balance, phase, etc.)	13
3.1.5	To enter menu	14
3.2	Navigating the setup menus	14
3.3	Menu options	14
3.3.1	Audio settings menu	16
3.3.2	Input-specific settings menu	16
3.3.3	Display settings menu	17
3.3.4	Shortcut menu	17
3.3.5	Network menu	18
3.3.6	Factory settings menu	19
3.4	Handheld remote control	20
3.4.1	Batteries	20
4	Firmware update	
4.1	Preparing the USB stick	21
4.2	Updating the unit's firmware	21
4.3	Emergency firmware update procedure	22
5	Troubleshooting	23
6	Specifications	24



1 Introduction

CH products are designed and manufactured in Switzerland by CH Precision Sàrl. We use fully discrete, fully balanced, fully complementary, ultra-short signal path circuits – but we combine them with sophisticated software control, monitoring and protection to ensure the highest possible levels of performance, operational consistency and versatility.

As a result, your L10 offers a number of operational features that are unique and probably unfamiliar. For that reason it is essential that you fully understand every aspect of the L10's operation if you are to enjoy its maximum possible performance.

1.1 Global audio options

- Mute
- Absolute phase polarity
- Global or local feedback
- Mono mode
- Balance / channel gain (up to 6dB of gain on either channel in 0.5dB steps)
- Maximum starting volume / global volume limit
- L10 internal stages calibration

1.2 Input-specific options

- Input configuration: active, hidden or bypass
- Input coupling: direct coupled or blocking capacitor
- Input impedance: high (94k Ω /47k Ω) or low (600 Ω /300 Ω)
- Input gain: \pm 6dB in 0.5dB steps
- Input calibration
- Input renaming

1.3 More user configurable options

- Display: color, content and brightness
- Define shortcut functions
- Network configuration
- Firmware version and update

1.4 The purpose of this manual

This manual will lead you through each step of the installation and set up procedure, in a clear and logical sequence. Although the operation and options might seem complex, they will quickly become second nature. But because of the sheer range of options available it is easy to overlook something unless you approach set up and configuration in a systematic way. If you take the time to follow the manual, it will ensure that you become completely familiar with the L10's many options and that your preamplifier delivers the best possible performance.

2 Setting up your L10

2.1 Safety notice

Like any piece of sensitive audio electronics, there are certain precautions that you should take in handling and installing your CH Precision L10 in order to protect yourself, your new equipment and your system.

- Always handle with care. The L10 preamplifier components are heavy, so have someone to help you when unpacking, re-packing or moving them around.
- Install both chassis of your L10 preamplifier on strong, stable supports capable of holding their weight. It is best to clear/prepare the supporting surfaces in advance.
- Do not install your L10 preamplifier near water.
- Do not expose the units to any kind of liquid.
- Do not install them under direct sunlight or near any heat source, such as a radiator or other apparatus generating heat.
- Do not install them in a confined space and make sure there is sufficient ventilation and airflow around and beneath each unit.
- Do not operate them under high ambient temperature (>40°C) or in extremely high humidity conditions.
- Only use options and accessories specified or recommended by CH Precision.
- Do not open the units or try to service them yourself. Always refer to a qualified technician for service, maintenance or upgrades. Failure to do so will void the unit's warranty

2.2 Unpacking

The L10's cartons are large and contain both the components and all of their accessories. You will need an open, preferably carpeted area in which to unpack them. Please also ensure that the rack or support space on which the L10 will be placed has been cleared and cleaned before you start. At this point it is also worth ensuring that the connectors on any interconnect cables are cleaned and that the power to your system is turned off. Each carton consists of an inner box and outer sleeve. It is easiest to empty one box at a time, before reassembling it to save space.

- Once you open the inner box, remove the top layer of white foam packaging. Inside you will see the component chassis and various accessories.
- With a helper, carefully lift the L10 component out of the box and place it to one side. Then carefully remove the plastic bag in which it is sealed.
- Remove the small, brown Accessory Pack and place it with its unit. Also remove the power cord and suction cup (if present) and the four levelling/grounding spikes.
- We recommend storing the Accessory Packs in a readily accessible place, so don't put them back in the cartons with the plastic bags when resealing them.



2.3 Package contents

Your L10 should arrive in two substantial cartons. Once unpacked these cartons and packaging materials should be stored safely in case you ever need to transport your units. When moving or transporting the L10 units, this should always be done in the original packaging.

The audio chassis carton should contain:

- The L10 preamplifier
- Four composite titanium/polymer spikes
- A suction cup (used to remove the four top covers)
- An accessory box containing:
 - an infrared remote control
 - a spike adjustment screwdriver
 - a Torx T-10 screwdriver
 - four support discs
 - four smaller, dimpled stacking caps
 - a USB stick containing the latest CH Precision firmware

The power supply chassis carton should contain:

- The L10 power supply with two captive umbilical cables
- A power cord
- Four composite titanium/polymer spikes
- An accessory box containing:
 - four support discs
 - four smaller, dimpled stacking caps

In case of damage to either chassis, or missing components, please contact your authorized dealer immediately. If your L10 units are still very cold from transport, please let them warm to room temperature in order to avoid condensation developing inside them.

2.4 Placing your L10, connecting the two chassis together and installing the spikes

Before positioning your L10 units, it is worth taking the time to make a few preliminary decisions.

- Decide how many (and which) inputs you will use. Familiarizing yourself with (and making a note of) their position on the rear of the audio chassis will be extremely useful when you come to actually make connections and allocate/configure those inputs.
- Decide whether you will use the CH Precision supplied levelling / grounding spikes. If an alternative system is to be used, please note that the lower part of each foot that is held by three screws can be removed to provide an easier access to the M10×1.5 central thread where a third-party system can be attached. Please note that the CH Precision casework is designed to support weight and ground energy in the corners only. If you choose to use third party supports they should be positioned in the same location as the unit's original feet and we do not recommend stacking components except using the supplied spikes and caps.
- If you do plan to use the CH spikes, use the blue suction cup to lift/remove the four circular covers in the top plate of each unit. Gently insert the titanium composite spikes into each exposed shaft and use the short red screwdriver to turn them enough to engage the threads at the bottom of each spike. Each internal thread is coated with a thin layer of grease during assembly to prevent galling between it and the titanium spike.



- Do not screw the spikes in too far at this point or they will protrude from the feet and potentially damage the supporting surface. Do not replace the top-caps yet.
- Check that the voltage selector on the L10 power supply unit is set to the correct local voltage and that the power switch is off (the 0 side depressed).

Now you are ready to place the units. Each chassis is heavy and the feet are fitted with rubber rings to protect the supporting surface, which makes it hard to slide the units. Having a partner to lift and help place each chassis will make things considerably easier.

- Place the power supply first, carefully planning the path to be taken by the two umbilicals before positioning the unit.
- Gently pull the umbilicals into position to be connected to the audio chassis, noting which is which thanks to the color identification rings.
- Move the audio unit as close as possible to the rack/support so that you can connect the umbilicals before moving it back into position. Connect the left umbilical to the left input socket and the right umbilical to the right input socket. The plugs on the umbilicals will only connect in one position, so turn the connector in the socket until you feel it engage and then gently push it home until you hear a locking sound.

**DO NOT force the umbilical connectors into the sockets.
This will risk damaging the connecting pins and disable your L10.**

- If you feel resistance when you insert the connector, check that you are trying to connect the proper pairs of umbilicals and connectors together. Please note that the two connectors have the same diameter but a different number of pins, so it is not possible to plug an umbilical in the wrong connector.
- Each L10 chassis is supplied with a set of four support discs. These have a groove machined in the upper face that fits over the rubber ring in the underside of each foot. Lift each corner of the chassis in turn and position the disc beneath each foot. The groove that interfaces with the rubber ring will ensure that the footer disc stays in place if you slide the unit.
- As well as making the units easier to position, the support discs can also offer a superior interface between the grounding spikes and the supporting surface. The spikes are designed to drain internally generated energy away from sensitive circuitry and into a dispersive support structure, but if the supporting surface is extremely hard or forms an impedance mismatch with the spike tips, the material and footprint of the support discs can function as a lossy mechanical buffer, easing the passage of mechanical energy out of the unit. As a rule, the support discs work well with very hard surfaces, but results will vary with system and supporting surface. Once set up and warmed up, compare the sound of the unit(s) with and without the discs in place.
- Use the red screwdriver to wind down each of the four spikes until they touch the surface (or disc) underneath. You will feel a slight resistance due to the chassis' weight. Then turn each spike by the same amount, for instance one more full turn. This should ensure that the load is evenly applied on all four spikes.
- It is worth using a spirit level to ensure that the L10 units are perfectly level. If they are not at this point of the setup, adjust the spikes with the screwdriver. Once this is done, simply check that all four spikes show the same resistance to turning. This means that the spikes are rigidly coupled to the supporting discs and equally loaded.
- Replace the top caps. Their magnetic coupling will hold them in place.

2.5 Stacking the L10 (or not)

Also included in the accessory packs is a set of small, dimpled stacking caps for each unit. These polymer inserts allow owners to stack the L10 units on top of each other, or on other CH components. However, this will inevitably compromise performance and should only be done when space is at an absolute premium.

The optimum support for any CH unit is to mechanically ground it to a stable, dispersive structure, either using the supplied spikes or an after-market solution. But if lack of space absolutely mandates the stacking of CH components, then using the supplied spikes and stacking caps will provide the best possible solution.

The stacking caps simply screw into the top of the spike wells, taking the place of the cosmetic caps. When a second unit is stood on top of them, its spikes can be wound down into the wells in the caps, providing a stable, safe and easily managed stacking option that improves mechanical termination and satisfies aesthetic and practical considerations. Make sure that you retain the cosmetic top caps and store them safely as you may well require them in the future if (or rather, when) your system or circumstances change.

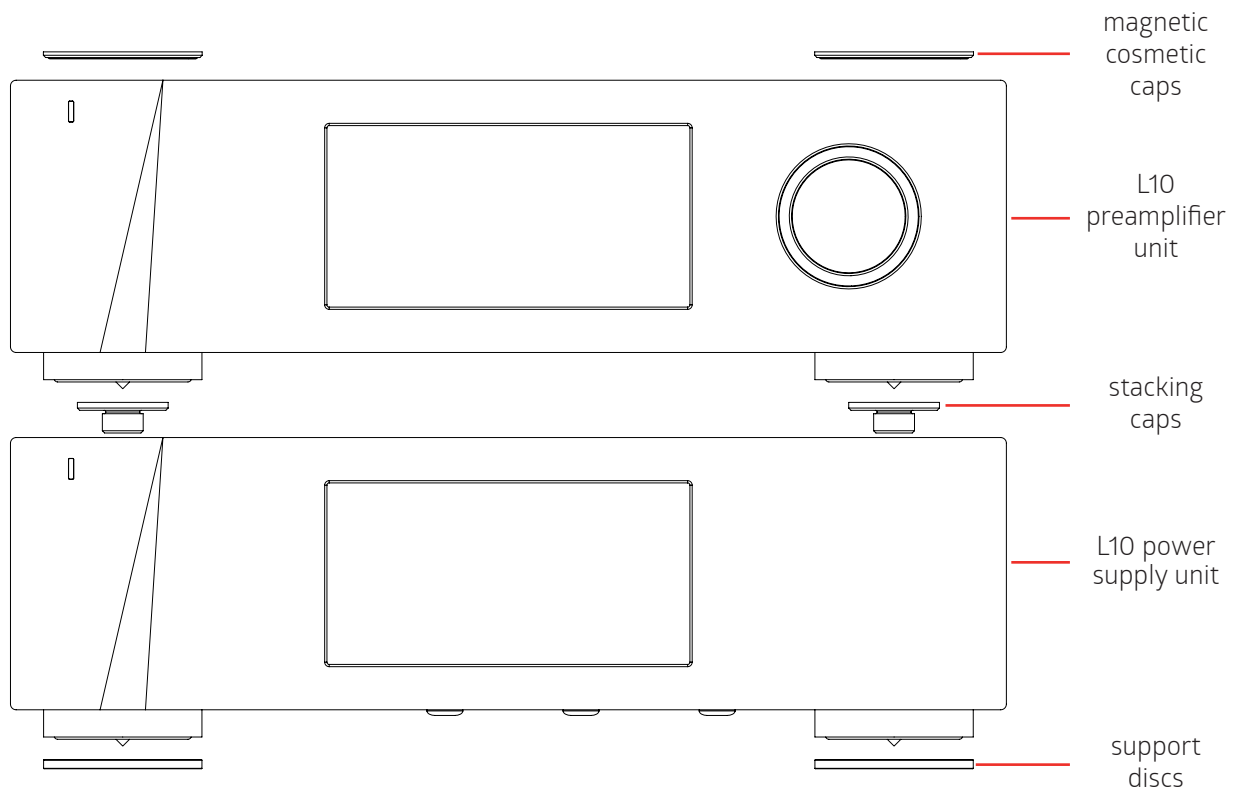

2.6 Connections

With the two (or four) L10 units placed and levelled, you are now ready to connect your signal cables. The rear panel layout is shown below:

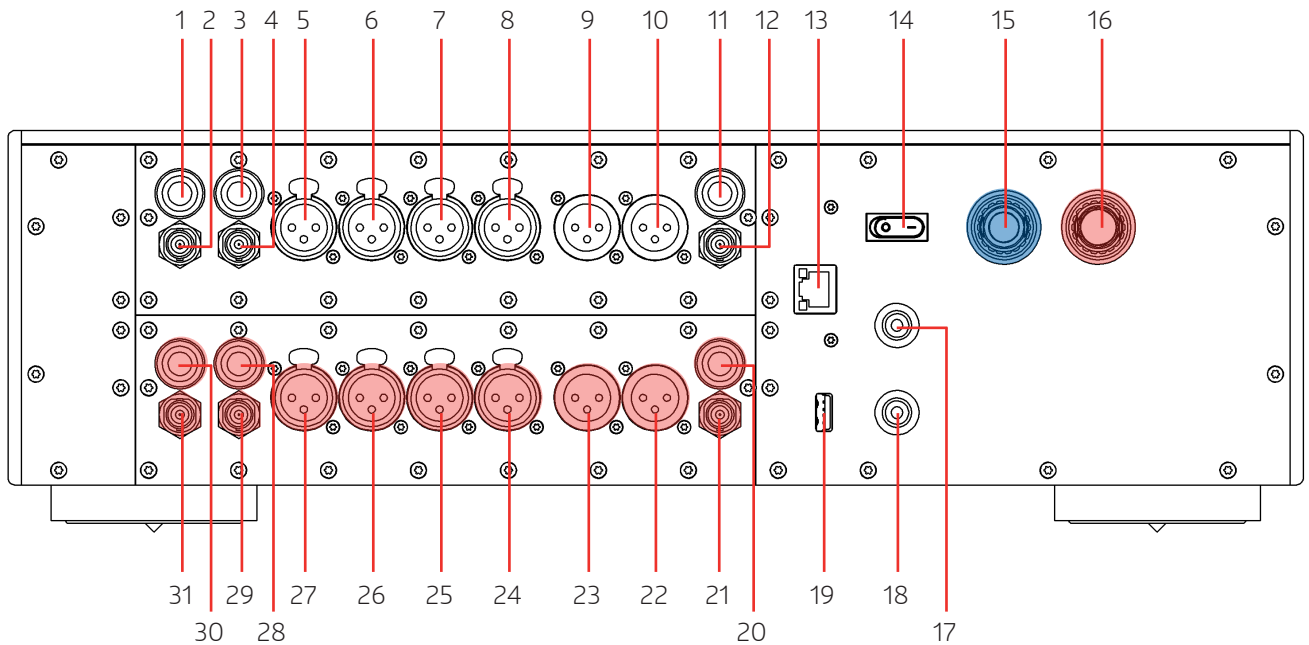

L10 audio unit rear panel connections

- | | |
|---|--|
| 1. RCA 1 left input | 16. Control (digital) power supply socket, to be connected to corresponding cable from power supply unit |
| 2. BNC 1 left input | 17. Signal ground (analog GND) socket |
| 3. RCA 2 left input | 18. Chassis earth (digital GND) socket |
| 4. BNC 2 left input | 19. USB socket for software upgrades only |
| 5. XLR 1 left input | 20. RCA right output |
| 6. XLR 2 left input | 21. BNC right output |
| 7. XLR 3 left input | 22. XLR 2 right output |
| 8. XLR 4 left input | 23. XLR 1 right output |
| 9. XLR 1 left output | 24. XLR 4 right input |
| 10. XLR 2 left output | 25. XLR 3 right input |
| 11. RCA left output | 26. XLR 2 right input |
| 12. BNC left output | 27. XLR 1 right input |
| 13. Ethernet port for command interface | 28. RCA 2 right input |
| 14. Ground lift: switch on to connect signal ground (analog GND) to earth (digital GND) | 29. BNC 2 right input |
| 15. Analog power supply socket, to be connected to corresponding cable from power supply unit | 30. RCA 1 right input |
| | 31. BNC 1 right input |

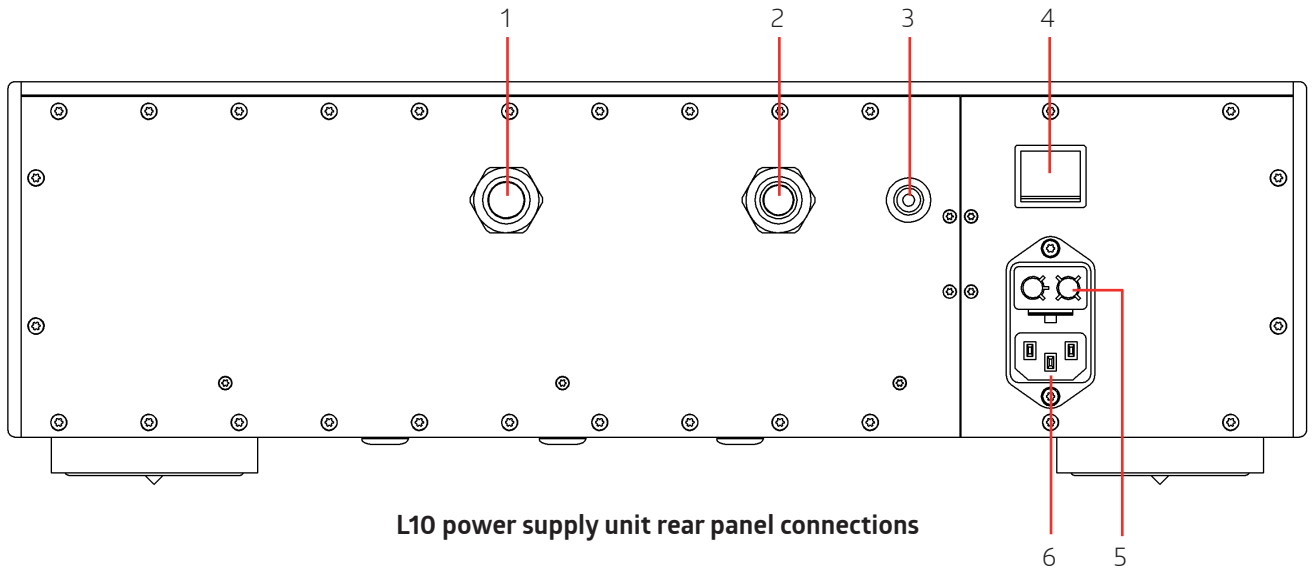

- | | |
|--|---|
| <p>1. Analog power supply umbilical cable, to be connected to the corresponding socket in the audio unit</p> <p>2. Control (digital) power supply umbilical cable, to be connected to the corresponding socket in the audio unit</p> | <p>3. Chassis earth (digital GND) socket</p> <p>4. Power on/off switch</p> <p>5. Fuses and voltage selector</p> <p>6. Power cord socket</p> |
|--|---|

You will note that as well as the array of conventional inputs and outputs, there are a number of other sockets available which are used for control and update functions.

2.6.1 USB port

The USB port is not a digital audio input. It is dedicated to upgrading the firmware of the L10. Do not use it for any other purposes. For more information please refer to the firmware update instructions in the dedicated chapter of this manual.

2.6.2 Ethernet port

The Ethernet port is used for two closely related functions.

- Connection to a local network router will allow control of the L10, its functions and configuration through the CH Control App, loaded on an Android device.
- In True Monaural configuration (standard or extended) the connection to an Ethernet network allows the two separate audio chassis to communicate in a Master/Client relationship, so that control settings track each other. One unit should be set as 'Master' and the other as 'Client', in the 'Network / Role' menu.
- In a situation where a four-chassis L10 is not connected to a network, an RJ45 Mirror lead connected between the two audio units will allow control synchronicity. In that case, select 'Direct-Link' in the 'Network / IP Settings' menu of both audio units.



2.6.3 Local area network considerations

We strongly recommend that you construct a dedicated local network for both music streaming and system control functions. It can be operated from locally located network switches, galvanically isolated from your main household network using affordable and readily available optical converters. This will improve the responsiveness of your setup, and keep as much high frequency noise out of your precious audio setup as possible.

2.6.4 Ground lift

The grounding switch allows owners to combine or separate the signal and chassis ground. In a complete CH system, this allows you to configure a single point, star grounding arrangement for the signal grounds. It can also prove useful in a situation where ground-loops generate hum.

2.6.5 Inputs

- Make sure that the L10 is switched off and disconnected from the wall socket.
- Connect each pair of source interconnects to the input you have chosen. On a Dual Monaural L10 the left inputs are the top sockets and the right inputs are the lower ones. In a four-chassis, True Monaural (or True Monaural Extended) set up, you will connect the left inputs to one chassis and the right inputs to the other.
- You have four balanced XLR inputs, two RCA and two BNC inputs per channel (and twice as many in four-chassis, Extended configuration).
- The inputs are all numbered. When making connections, ensure that you note which source is connected to which input, so that you can identify each one correctly in the configuration menu. You can later give a more meaningful name to the L10 input that are connected to a source component, and hide the ones you won't use for now.

2.6.6 Outputs

- The L10 is equipped with two pairs of balanced XLR and single pairs of RCA and BNC outputs. This provides plenty of flexibility to connect your power amplifiers, even for bi-amplification.
- The connection of the L10 to your system will depend on the number (and type) of amplifiers you are using. Please see the configuration diagrams on the Quick Start Guide.
- If you need additional outputs, then the four-chassis extended configuration will provide twice the number.

2.6.7 AC Power

- With all the signal inputs and outputs connected, you can now connect the IEC power cord to the input socket on the L10 power supply and switch the units on. You should see the red bar in the CH logo in the top-left corner of each front panel illuminate.

Your L10 is now in standby mode and ready to be turned on and configured.

3 How to configure and operate your L10

The L10 amplifier is operated either from the unit's front panel display and concentric control or from the CH Control app. The initial set up should be done using the front panel buttons and the menus shown on the display. Once configured for inclusion in the Control App, all parameters can be adjusted or re-set remotely.

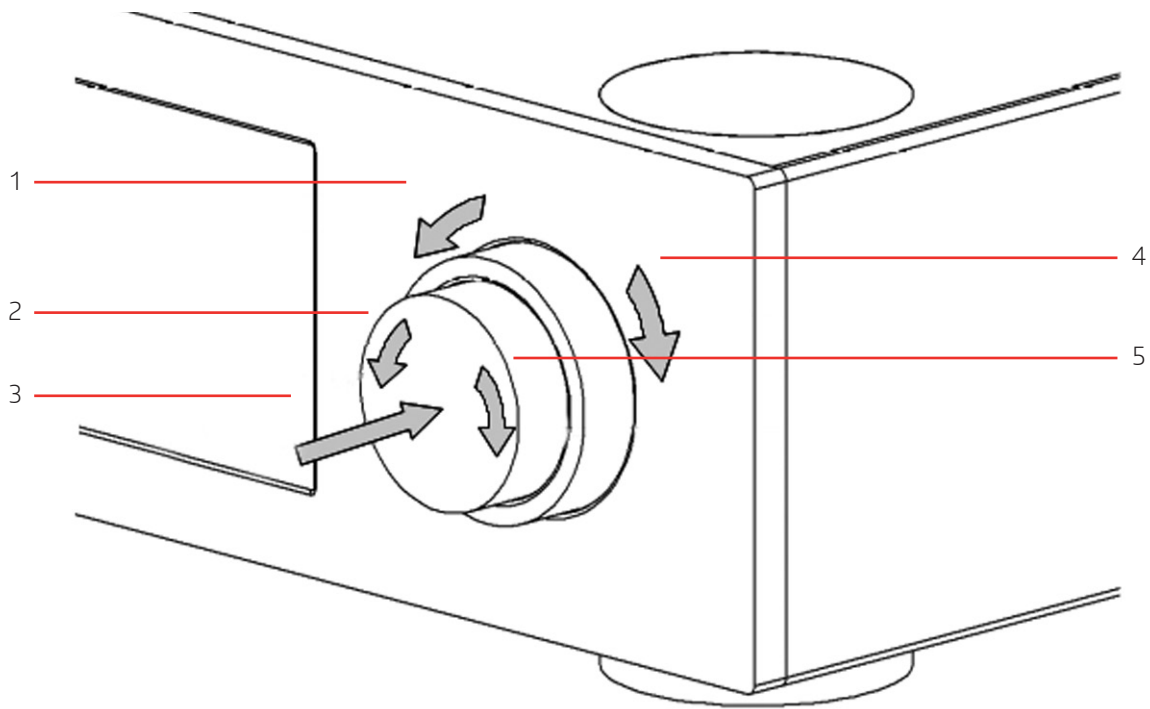

User control knob movements

- 1. External ring rotate Left [$\ll E$]
- 2. Central ring rotate Left [$\ll C$]
- 3. Central knob push. There are two types of push:
Normal Push [NP] and Long Push [LP]
- 4. External ring rotate Right [$E \gg$]
- 5. Central ring rotate Right [$C \gg$]

In use, your L10 has two operating modes: Normal mode and Menu mode.

3.1 Control actions in normal mode

In general use, the rotary control allows you to switch the L10 on and off, select inputs or short-cut functions and adjust the volume level.

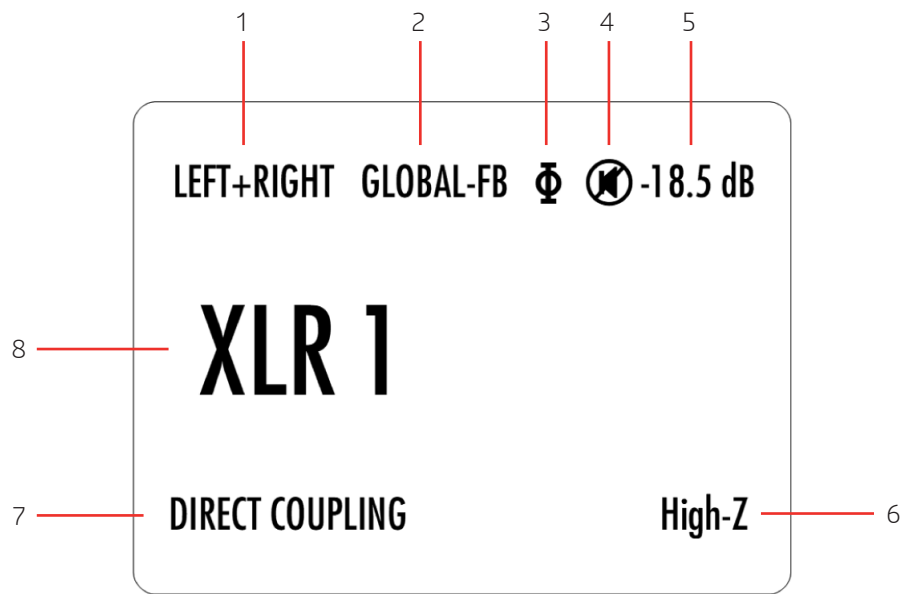

Normal mode display elements

- | | |
|--|---|
| <p>1. Handled channel (in true monaural) or channel pair (in dual monaural)</p> <p>2. Indicates if output stage uses global feedback (GLOBAL-FB) or local feedback (nothing is displayed in this case)</p> <p>3. Absolute phase polarity indication. If the Φ symbol is present, polarity is reversed</p> <p>4. Mute or mono indication. If the M symbol is present, the L10 output is muted.</p> <p>5. Volume</p> | <p>6. Impedance termination indication. High-Z is displayed when no termination resistor is engaged, 600Ω or 300Ω when a termination resistor is activated.</p> <p>7. Input coupling state. DIRECT COUPLING means there is absolutely no capacitor in the signal path, CAP COUPLING means the selected input goes through a high performance polypropylene capacitor</p> <p>8. Input source name. Each input source can be renamed through L10's menu</p> |
|--|---|

3.1.2 To select an input

Rotate the outer ring left [$\ll E$] or right [$E \gg$]. The display will show the selected input.

3.1.3 To alter volume

Rotate the central knob left [$\ll C$] or right [$C \gg$]. The display will give a numerical and graphical readout of volume level.

3.1.4 To engage shortcuts (mute, balance, phase, etc.)

Short push on the central knob [NP] to cycle through shortcut options. Display will show selected shortcut function: Rotate either control knob left [$\ll C$]/[$\ll E$] or right [$C \gg$]/[$E \gg$] to alter shortcut parameter – mute/unmute etc. Note that the current input is automatically pre-selected for all input-specific parameter that are configured through a shortcut.



3.1.5 To enter menu

After the last shortcut is a screen labelled Detailed Setup on the display. **With the display showing Detailed Setup, rotate either the central or external control right [C>]/[E>>] to enter Menu Mode.**

3.2 Navigating the setup menus

Once in Menu Mode, the various menu options are shown on the display and navigated using the central control knob.

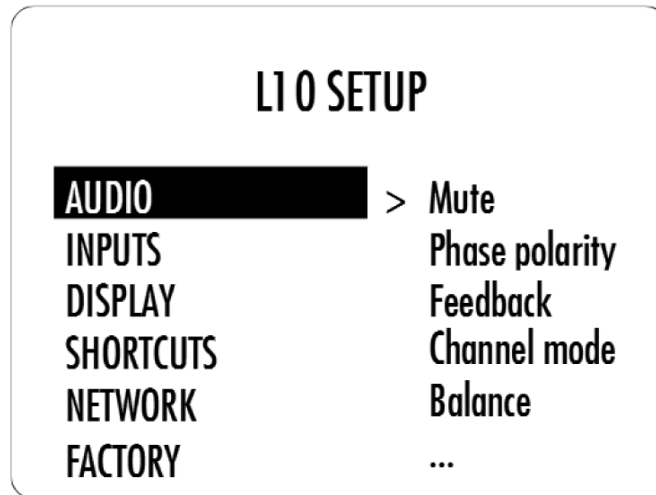

L10 SETUP screen items

The display shown above is the main Menu, with the various sub-menus shown in the left column and the parameters adjustable in the selected menu (in this case the audio Settings menu) in the right column.

- Rotating the central knob moves the menu selection up and down the left column of the screen (the selected sub-menu/ parameter is highlighted). As each sub-menu/parameter is selected, the options available will be shown in the right column.
- Once the correct menu/parameter has been selected, a short push on the central knob [NP] or [E>>] will enter that selection. Once you have navigated to the correct menu and set the required parameter, another short push on the central knob [NP] will store that setting.

Note that some parameters are input-specific, while others are global. For instance, you can individually adjust the input gain or coupling (direct or cap) of all L10 input, while the feedback setup (local or global) or absolute phase polarity are global parameters. All input-specific parameters are located in the INPUTS menu.

3.3 Menu options

If you study the menu tree laid out below, you can see the various options and where to find them. It may look confusing to start with, but it soon becomes clear and easy to navigate.

Below the menu tree is a list of the various sub-menu options and their significance. These options are the key to configuring your L10 to deliver the best performance, tailored user interface and coupling with your system. It is worth studying the various options and their importance as they will directly affect your enjoyment of your system.



L10 preamplifier menu structure

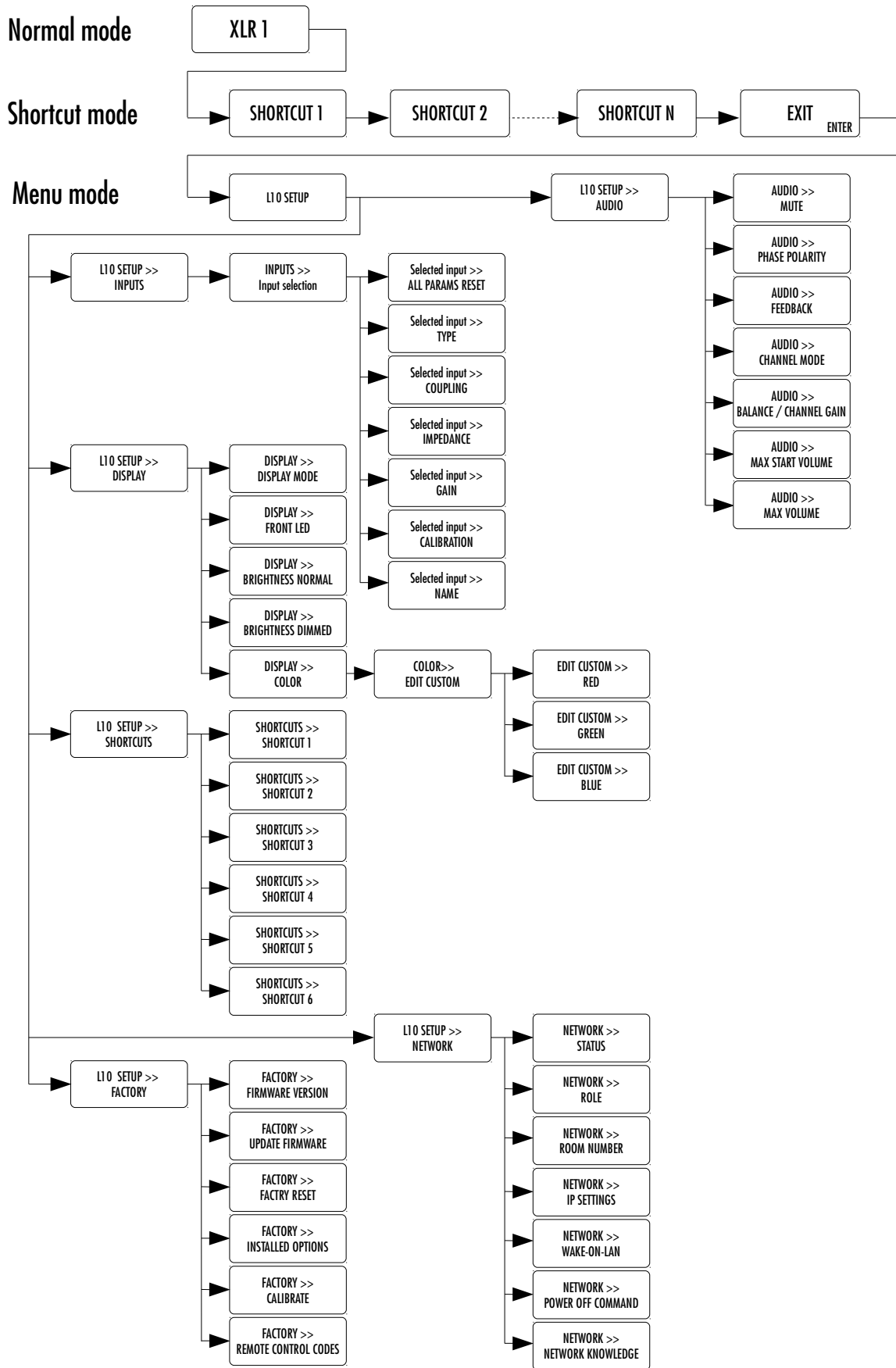



3.3.1 Audio settings menu

- Mute
Mutes or unmutes the audio output.
- Phase polarity
Allows you to reverse the absolute phase of the audio output.
- Feedback
Selects if the L10's output stage features local or global feedback.
Local feedback setting (the default setting on the L10) is more musically expressive.
Global feedback setting delivers greater control and precision. When selected, GLOBAL-FB shows in the status display screen.
We recommend comparing them and selecting the one you enjoy the most in your system. Your preferred choice may vary with the musical program.
- Channel mode
Left and right input signals can be summed together to generate a monaural signal. Default value of this parameter is stereo. Obviously, this feature is not available with a four chassis, true monaural L10 setup, as there is no easy way to combine the monaural channels of the left and right L10 chassis.
- Balance / Channel gain
6 dB of L/R balance control in 0.5 dB steps for an L+R dual monaural L10.
±6 dB of left, right, left surround, right surround, center or sub channel gain for other L10 configurations (either true monaural or surround channel configuration).
- Maximum start volume
The L10 normally resumes its previous volume level upon startup. This setting allows to limit it to a lower value to avoid bad surprises if the L10 was previously turned off while a very high volume level was used.
- Maximum volume
User-configurable absolute volume limit for the L10 (-30dB to 0dB in 10dB steps, or no limitation – up to +18dB).

3.3.2 Input-specific settings menu

- Input type
Selects whether the selected input is a standard (volume controlled), hidden or by-passed (processor) input. Hidden outputs will be removed from the source switching cycle so that only active sources appear.
- Input coupling
Sets individual coupling type (DC or AC) for each input. DC coupling delivers superior stability, dynamics and soundstaging. AC coupling prevents DC noise entering the L10 from a source connected to that input – useful for blocking DC generated by tubes during their warm up cycle for instance.
- Input impedance
Sets individual impedance termination per input.
High impedance (47kΩ for single-ended inputs, 94kΩ for balanced inputs) means the input won't draw any current from the upstream device's output, delivering the best possible resolution and dynamics.
600Ω (300Ω for single-ended inputs) means a termination resistor is activated, increasing the noise immunity of the interconnect while drawing a bit of current from the upstream device's output. This eliminates induced noise at the cost of dynamic range and precision.



- **Input gain**
Sets input gain for each individual input, $\pm 6\text{dB}$ in 0.5dB steps.
Allows owners to equalize volume levels for different inputs and set system gain for optimum dynamic performance.
- **Input calibration**
Analyzes upstream device's DC level to best adapt its DC-cancellation scheme.
- **Input name**
Each input can be allocated a specific name or identifier, up to 12 letters or numerals long. Text is entered using the rotary control. Scroll through the alpha/numeric listing until you have the letter, number, space or punctuation required.
A short press [NP] saves that selection and shifts the cursor to the next space. Don't forget to save the name with a short press [NP] when complete. Alternatively, you may want to rename your L10 inputs directly from the Android CH Control App.

3.3.3 Display settings menu

- **Display mode**
Allows the user to choose what information is displayed and whether the display remains on or switches off after a short time. Options are volume readout scale, general status display or Off.
- **Front LED**
Allows the user to turn the red power LED off when the units are active rather than in standby.
- **Display brightness and gamma**
Allows you to set the brightness of the display in operating mode (10 – 100%), and to fine tune the high brightness gamma curves to perfectly match the brightness and color of other displays.
- **Display brightness (dimmed)**
Allows you to set the brightness of the display when dimmed between operations (10 – 30%), and to fine tune the low brightness gamma curves to perfectly match the brightness and color of other displays.
- **Display color**
Lets the user select display color from a choice of seven standard shades or a user defined RGB color.

3.3.4 Shortcut menu

The L10 allows you to establish up to six shortcuts, taking you directly to almost any parameter in any menu. The L10 is preprogrammed with Mute and Phase Polarity as shortcuts one and two. After scrolling through the latest shortcut, the next screen that the L10 displays is the entry port to the L10 menu. It reads Detailed Setup.



3.3.5 Network menu

- **Status**
Shows a list of compatible devices detected on the LAN.
- **Role**
When physically connected to a network, the L10 can ignore this network (offline) or connect to it as either the master unit (it will transmit push-button commands to all compatible client units) or as a client (it will ignore push-button entries and receive commands only from the master device). This networking facility allows system-wide sharing of commands among CH products (such as mute or power up/down).
- **Room number**
Defines the room in which the L10 is located for multi-room applications.
This prevents CH Precision units connected to the same network but located in different systems/rooms to interact with each others.
- **IP settings**
Auto should be selected if the L10 is connected to a router with DHCP server feature.
Direct-Link should be selected when an RJ45 Mirror lead directly connects a Master L10 to a Client L10.
More advanced settings are available if needed.
- **Wake-on-LAN**
If 'No' is selected, the L10 cannot be switched on from the CH-Control App.
If 'Only If POE' is selected, connecting the L10 to a Power Over Ethernet switch will allow it to be switched on via the CH-Control App (Standby consumption will be less than 0.5W).
If 'Yes' is selected, the L10 can always be switched on by the CH-Control App (Standby consumption will be less than 2W).
- **Power off command**
If Yes is selected, the L10 will enter standby mode when it receives a Power Off command from the LAN.
It will remain on if No is selected. This is useful if you want to keep your L10 on even when you turn off the rest of your system.
- **Network knowledge**
The L10 keeps track of all discovered devices, in order to turn them on if it is set as a Power Master.
If the audio system evolves, the list of devices can be cleared by this function.



3.3.6 Factory settings menu

- **Firmware version**

Indicates the version of the firmware that the L10 is currently running. Periodically check CH Precision's website to see if a newer version is available. It could add new features or correct bugs.
Note that the CH Control App indicates that a device is not up to date by displaying its name in orange instead of red.
- **Update firmware**

Selecting Update launches the L10 firmware update process. A USB flash disc drive with a valid set of firmware must be inserted in the A-shaped USB port. Please report to the corresponding section of this manual for more detail on firmware update procedure.
- **Factory reset**

Resets all parameters to their default factory values. This can be useful if you made some changes that you don't know how to revert. Note that it is also possible to reset small subsets of parameters to their default values from other locations in the menu tree.
- **Serial number**

Displays the serial number of your L10. This serial number is also written on a sticker at the back of your L10.
- **Installed options**

List the hardware configuration of your L10.
- **Calibrate**

Launch automated self calibration to measure and compensate DC at all stages of the L10 signal path. This calibration process is conducted at CH Precision factory prior to packing any L10.
In order to avoid overriding these factory measured valued with inaccurate ones, the L10 must be powered for at least 1 hour before this function is available, to ensure the L10 is warmed up and all internal stages have stabilized.
- **Remote control codes**

Selects which set of infra-red RC5 commands the L10 will respond to.
Pre1 is the standard RC5 Preamplifier codes as used by the remote control handset supplied with the L10 and L1.
Pre2 is the alternate set of RC5 commands used by the C1.
When 'None' is selected, the L10 can no longer be controlled by an infra-red remote control.



3.4 Handheld remote control

The L10 preamplifier is delivered with an infra-red remote to drive the unit's basic operational functions. The provided remote control is not intended to be used to configure the unit. It can be magnetically attached to the side panels of the L10 audio unit for storage.

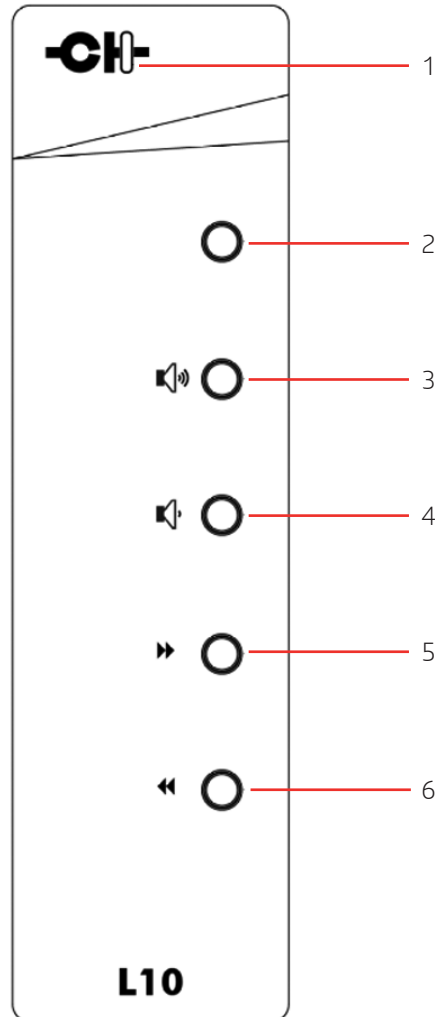

L10 preamplifier infra-red remote control

- | | |
|--|--|
| 1. Remote control activity LED | 5. Next input [NP] / absolute phase inversion [LP] button |
| 2. Mute [NP] / Standby [LP] button | 6. Previous input [NP] / local/global feedback [LP] button |
| 3. Volume up [NP] / fast volume up [LP] button | |
| 4. Volume down [NP] / fast volume down [LP] button | |

3.4.1 Batteries

If the Remote Activity LED fails to light then you will need to change the batteries in the handset. The T-10 torx screws that hold the black bottom plate can be removed with the provided screwdriver. The remote takes two AAA batteries.



4 Firmware update

4.1 Preparing the USB stick

The firmware of all the CH Precision units can be updated using the USB port located at the back of the unit. Before starting the firmware update, it is necessary to load a USB stick with files containing the new firmware. Use a FAT32 formatted USB 2.0 stick. Please note that some USB sticks might not be detected by the L10 USB port. CH Precision recommends the use of the USB sticks that is delivered in the accessory pack of the unit. The following procedure describes how to load the USB stick with the correct files:

1. Download the latest L10 firmware file from www.ch-precision.com.
2. Decompress the .zip file and copy the decompressed files to the root of your USB stick.

Make sure all the files are present at the root of your USB stick, and that only one version of these files is present. Any missing file will make the firmware update procedure fail, while multiple versions of the same unit's firmware can lead to unstable L10 behavior after update.

4.2 Updating the unit's firmware

1. Perform the operations described in section 4.1.
2. Connect the USB stick to the USB port located at the back of your L10 audio unit.
3. Navigate to the FACTORY SETTINGS menu and select the UPDATE FIRMWARE item.
4. Start the Firmware Update process by pushing the encoder button. Please note that the unit can perform several resets (the display briefly turns off and on) during the procedure.
5. Once the firmware update is complete, the unit automatically goes into Standby mode. The front red logo LED will switch from flashing mode to on mode. Remove the USB stick and turn the unit on. The new firmware is now active. To verify that the firmware update was effective, navigate to the FACTORY SETTINGS menu and select the FIRMWARE VERSION item. The displayed firmware revision should match the firmware revision of the files copied to the USB stick.

Note: The firmware update process lasts 5-10 minutes, do NOT interrupt it!

When performing a firmware update, do NOT press or turn any of the unit's front panel button/encoder, do NOT unplug the unit from the AC wall socket and do NOT turn the mains power switch off. Interruption of the firmware update procedure may result in corrupted firmware and a malfunctioning unit. In case something went wrong during a firmware update and the unit is malfunctioning, apply the emergency firmware update procedure described in the next section.



4.3 Emergency firmware update procedure

Perform the following Emergency Firmware Update procedure if your unit doesn't power up normally.

1. Perform the operations described in section 4.1.
2. Power the unit off (back panel mains power switch to OFF on the power supply unit).
3. Push the central knob and keep it pushed while powering up the unit (back panel mains power switch to ON). Keep the central knob pushed in for a couple more seconds after turning the unit on.
4. The unit performs the emergency firmware update. Once the operation is complete, the unit automatically goes into Standby mode. Remove the USB stick and turn the unit on. The new firmware is now active. To verify that the firmware update was effective, navigate to the FACTORY SETTINGS menu and select the FIRMWARE VERSION item. The displayed firmware revision should match the firmware revision of the files copied to the USB stick.
5. If the emergency firmware update procedure fails, try the same procedure again using a different USB stick.
If the failure persists, turn off your unit and contact your authorized dealer for assistance.

Note: The emergency firmware update procedure lasts 5-10 minutes, do NOT interrupt it!



5 Troubleshooting

Never try to reconnect an umbilical power cable or the mains power cable while your L10 is not fully off. If any power cable gets disconnected by mistake while your L10 is on, just let it safely automatically turn off. Do not try to interfere with the emergency power down procedure of the device. Then wait a couple of minutes before plugging the umbilical power cables back.

Error	Action
No power	Check that both umbilicals connecting the audio and the power supply units are firmly locked. Check the mains power cable of the power supply unit. Check the power switch at the back of the power supply unit Check the mains fuses on the back of the power supply unit
No sound (general)	Check that your source is playing Check that your amplifier is turned-on and speakers are connected Check that the L10's volume setting is not too low Check that the correct input is selected on your L10
No sound ("M" is displayed)	Your L10 is muted (display area 4 M must be off for the unit to output signal). Unmute using first RC button
Lost in the settings?	Restore factory settings and start your setup again
Software update fails	Try Emergency Software Update procedure If it fails, download the latest L10 firmware from www.ch-precision.com , prepare a software update image on the provided FAT32 formatted USB stick and follow the Emergency Software Update procedure again
USB flash drive for firmware update is not detected by L10	Please try another brand of USB flash drive (e.g. Sandisk or the provided stick).

If the error cannot be corrected using the information from the above table, disconnect the unit from AC wall socket and from the rest of your system and contact your authorized dealer for assistance.



6 Specifications

General

User control	Dual concentric rotary knob with push function, CH Control Android app
Display	800×480 24bits RGB AMOLED
Power supply	Selectable 100V, 115V or 230V AC, 47Hz to 63Hz
Power consumption (Standby)	< 1W
Power consumption (Normal operation)	Max 400W
Operating conditions Temperature:	+5C to +35C, humidity: 5% to 85% (no condensation)
Dimensions of each chassis (W x D x H)	440mm x 440mm x 120mm (main body) 440mm x 470mm x 132mm (overall including connectors and feet)
Weight Audio unit:	20kg
Power supply unit:	23 kg
Firmware update / Control	USB port for firmware update / Ethernet based system control

Analog inputs

Balanced inputs	4x XLR connectors per board, 94k Ω or 600 Ω load (user selectable)
Single-ended inputs	2x RCA connectors per board, 47k Ω or 300 Ω load (user selectable) 2x BNC connectors per board, 47k Ω or 300 Ω load (user selectable)
Maximum input level	+26dBu (16Vrms) balanced, +20dBu (8Vrms) single-ended

Analog outputs

Balanced outputs	2x XLR connectors per board
Single-ended outputs	1x RCA connector per board, 1x BNC connector per board
Output and I/V stages	0% global feedback (100% local), or 100% global feedback (0% local)
Maximum output level	+29dBu (16Vrms) balanced +23dBu (8Vrms) single-ended
Volume control range	-100dBu to +18dBu in 0.5dB steps
Frequency response (-3dB point)	DC-1MHz
Signal to Noise Ratio (SNR, unweighted)	141dB, unity gain and at maximum input level
Total Harmonic Distortion + Noise (THD+N)	<0.0008%, 1kHz, unity gain
Output noise	-112dBu (1.8 μ Vrms) balanced, -115dBu (1.3 μ Vrms) single-ended

Remote control

Remote control type	Infrared. Uses RC5 codes. Range: 10m (line of sight)
Remote control batteries	2x AAA type



Design and Specifications are subject to change without notice. Weight and dimensions are approximate. Illustrations are informative only and may differ from the actual production model. Enclosure designed by Momentum Industrial Design – www.momentum.ch

FCC-Notice

Note: This equipment has been tested and found to comply with the limits for a Class B digital device, pursuant to Part 15 of the FCC Rules. These limits are designed to provide reasonable protection against harmful interference in a residential installation. This equipment generates, uses and can radiate radio frequency energy and, if not installed and used in accordance with the instructions, may cause harmful interference to radio communications. However there is no guarantee that interference will not occur in a particular installation.

If this equipment does cause harmful interference to radio or television reception, which can be determined by turning the equipment off and on, the user is encouraged to try to correct the interference by one or more of the following measures:

- adjust or relocate the receiving antenna
- increase the separation between the equipment and the receiver
- connect the equipment into a mains outlet on a circuit different from that to which the receiver is connected
- consult the dealer or an experienced radio/TV technician for help

Disposal – Environmental care

Directive 2002/96/EG of the European Parliament requires consumer electro-technical appliances to be disposed separately and have to be indicated with the following symbol. Should you dispose this component please do so in conformity with local and global legal and environmental regulations and according to best practices. We strongly encourage you to recycle any batteries used with this component.



CH PRECISION SÀRL

Z.I. LE TRÉSI 6D · 1028 PRÉVERENGES · SWITZERLAND

+41 (0)21 701 9040 · info@ch-precision.com

www.ch-precision.com